

FFTH1022U2

HOME COMFORT THROUGH-THE-WALL AIR CONDITIONER/HEATER



PRODUCT DIMENSIONS

Height	14-9/16"
Width	24"
Depth	20-5/8"

MORE EASY-TO-USE FEATURES

Supplemental Heating Option

With our supplemental heating capability, you can be comfortable regardless of the temperature outside — you have both heating and cooling solutions!

Sleep Mode

With Sleep Mode, the temperature gradually increases a few degrees over the evening, saving energy and creating a comfortable environment during the evening hours.

Remote Control

Offers you the flexibility to control the temperature and fan speed from anywhere in the room.

Effortless™ Clean Filter

Our antibacterial filter reduces bacteria, room odors and other airborne particles for a healthier, more comfortable environment.

Power Cord

Comes with an extra long three-prong cord — makes extension cords unnecessary.

Effortless™ Restart

Automatically resumes operating at its previous settings when power is restored to your unit.

Clean Filter Alert

Alert notifies you when your filter needs to be cleaned so you don't have to keep track of it yourself.

Ready-Select® Controls

Easily select options with the touch of a button.

SIGNATURE FEATURES

Effortless™ Temperature Control

Our air conditioners maintain the preset room temperature, so you will remain comfortable at all times.

Programmable 24-Hour On/Off Timer

With the 24-Hour On/Off Timer, you can ensure your home will be cool and comfortable when you want it to be without having to worry about running up your utility bills. The built-in timer allows you to preset the unit to turn on and off in half-hour increments.

Energy Saver Mode

Reduce your utility bills in this mode. It cools similarly to central air, with the unit turning on and off at different intervals to ensure the room temperature stays at the set temperature.

Multi-Speed Fan

Features three different fan speeds, for more cooling flexibility.

PERFORMANCE	BTUs
Cool	10,000/9,800
Heat	10,600/8,600

THROUGH-THE-WALL AIR CONDITIONER/HEATER

PERFORMANCE

BTU (Cool)	10,000/9,800
BTU (Heat)	10,600/8,600
Dehumidification (Pints/Hour)	2.2
Cool Area (Up To Sq. Ft.)	450
Combined Energy Efficiency Ratio	9.6
Energy Efficiency Ratio	9.6

ELECTRICAL

Volts	230/208
Amps (Cool)	4.6/5.0
Amps (Heat)	15.8/14.5
Watts (Cool)	1,040/1,020
Watts (Heat)	3,450/2,820
Length of Power Cord (Min./Max.)	5.5'/6'
Plug Type (NEMA)	LCDI (6-20P)

FEATURES

Electronic Controls	Ready-Select® Controls
Fan Speeds (Cool/Fan/Heat)	3/3/3
Low Voltage Start-Up	Yes
Auto Cool Function	Yes
Energy Saver Mode	Yes
Sleep Mode	Yes
Filter Check	Yes
24-Hour On/Off Timer	Yes
Clean Air Ionizer	
Remote Control	Full-Function with Heat
Air CFM (High/Med/Low)	290/265/253
Air Direction Control	6-Way
Fresh Air/Exhaust Vent/Closed	No/No/Yes
Filter Type	Antibacterial Mesh
Filter Access	Slide-Out
Slide-Out Chassis	
Warranty ¹	Yes

OPTIONAL ACCESSORIES

Through-The-Wall 18" Sleeve Kit	PN# 5304514430
Trim Kit (for larger existing sleeve)	Included
Architectural-Style Exterior Louvered Grille	PN# 5304515640

CERTIFICATIONS

Performance	AHAM
-------------	------

SPECIFICATIONS

Refrigerant	R410a
Shipping Weight (Approx.)	91 Lbs.

¹Warranty five (5) years full parts and labor.

PRODUCT DIMENSIONS

A - Height	14-9/16"
B - Width	24"
C - Depth	20-5/8"
D - Max. Wall Thickness	18"

SLEEVE CUTOUT DIMENSIONS

Height	15-5/8"
Width	25-15/16"

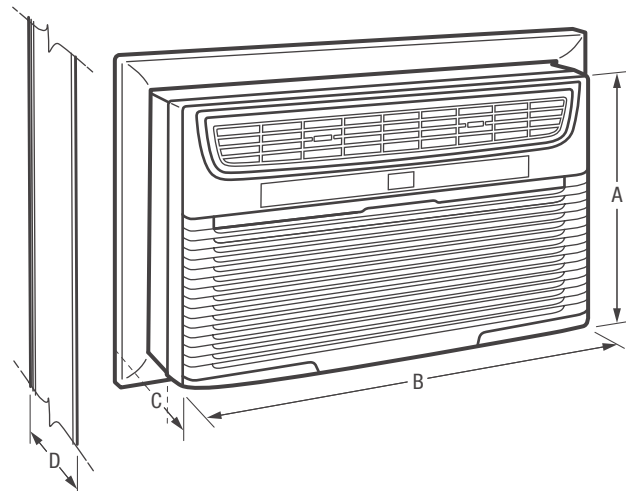

Plug Type (NEMA)
6-20P



Note: For planning purposes only. Always consult local and national electric, gas and plumbing codes. Refer to Product Installation Guide for detailed installation instructions on the web at frigidaire.com.

Specifications subject to change. Accessories information available on the web at frigidaire.com

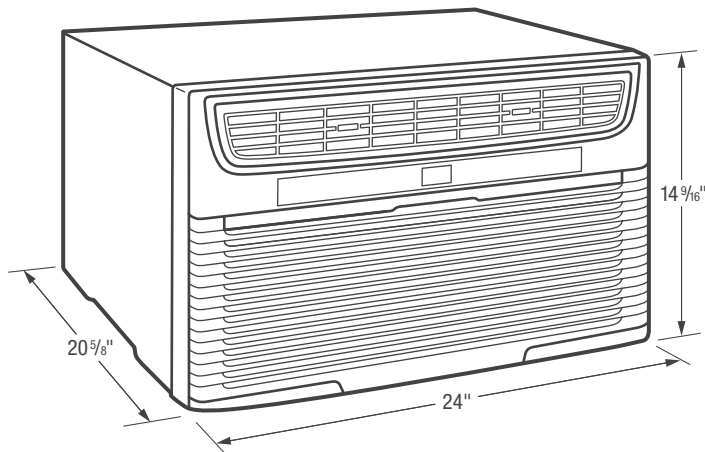

Through-The-Wall 18" Sleeve Kit
(PN# 5304514430)

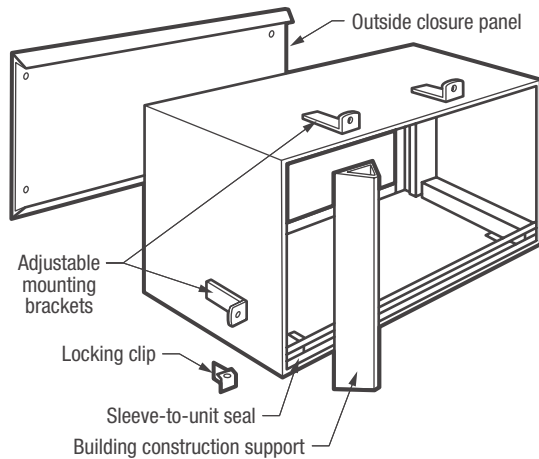

Through-The-Wall Installation

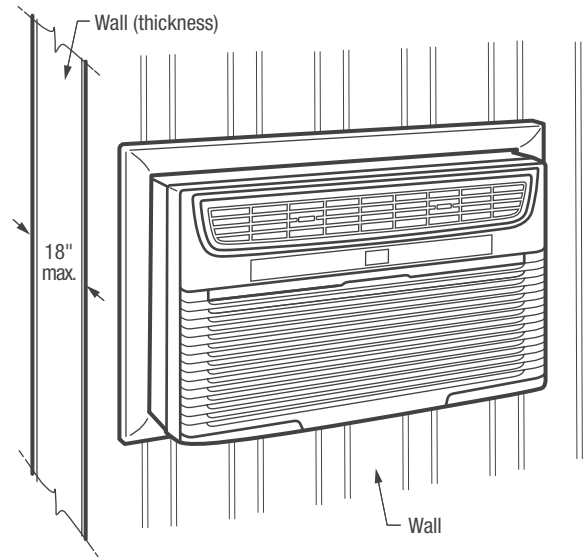

Plug Type (NEMA)
6-20P

INSTALLATION SPECIFICATIONS

- Product Shipping Weight (approx.) - 91 Lbs.
- Single phase 3-wire cable, 230/208 Volt, 60 Hertz AC only electrical supply with ground required on separate circuit fused on both sides of line.
- Amps @ 230/208 Volts = (Cool) 4.6/5.0 Amps / (Heat) 15.8/14.5 Amps
- Recommended Circuit Breaker - 20 Amps
- Unit equipped with 230/208V 3-wire power supply cord, NEMA plug type 6-20P, approximately 72" long.
- Unit's increased performance characteristics result from two rear intakes. For unit to operate at maximum efficiency, carefully follow complete, detailed new or replacement installation instructions provided in Product Installation Guide on web.
- Unit requires rearward slope when installation is complete, to allow condensate to drain from rear of sleeve.

NEW INSTALLATION

- For new installation, Frigidaire® Through-The-Wall 18" Sleeve Kit PN# 5304514430 available. Recommended for proper installation.
- Through-the-wall installation requires 18" maximum wall thickness.
- For energy-saving purposes, install unit in shady location, preferably a northern exposure; and do not block airflow inside with blinds, curtains or furniture; or outside with shrubs, enclosures or other buildings.

REPLACEMENT INSTALLATION

- When replacing existing air conditioner with new unit, refer to Product Installation Guide on web to identify existing wall-sleeve manufacturer and size compatibility. If proper installation and slope are suspect, then correct installation of Frigidaire® Through-The-Wall 18" Sleeve Kit PN# 5304514430 recommended.
- Use of existing wall sleeve to mount new unit requires original sleeve be in sound structural condition with rear grille that attaches securely, or rear flange that serves as stop for unit.
- Preferable installation option, for increased efficiency and possibility of drafts reduced, requires existing rear grille (*mounted to sleeve*) be replaced with new unit's rear air-directional louvered grille (*provided in accessory kit, shipped with unit*). Non-preferable installation option of directly mounting rear louvered grille to unit can be considered, requiring grille be mounted to unit prior to sleeve installation.
- Existing decorative exterior grille may be left in place, provided that proper air-directional rear louvered grille is installed.
- For installation into larger existing sleeve, optional Trim Kit PN# EA120T available.

OPTIONAL ACCESSORIES

- Through-The-Wall 18" Sleeve Kit - (PN# 5304514430).
- Trim Kit (*for larger existing sleeve*) - Included.
- Architectural-Style Exterior Louvered Grille - (PN# 5304515640).

